



JST06K-600CW 6A TRIAC

Rev.A.1.1

W220,-2 (4C)-12T 40(ON5 T):0d(4)- BDC 7T 11f20T 0V07 \$ 252 Tm2-(6)22On5 T2h Tç-3

Peak pulse voltage ($T_j=25$; non-repetitive, off-state; FIG.8)	V_{pp}	3	kV
--	----------	---	----

ELECTRICAL CHARACTERISTICS ($T_j=25$ unless otherwise specified)

Symbol	Test Condition	Quadrant	Value		Unit
I_{GT}	$V_D=12V R_L=33$	- -	MAX.	35	mA
V_{GT}		- -	MAX.	1	V
V_{GD}	$V_D=V_{DRM} T_j=125$ $R_L=3.3k$	- -	MIN.	0.2	V
I_L	$I_G=1.2I_{GT}$	-	MAX.	50	mA
				60	

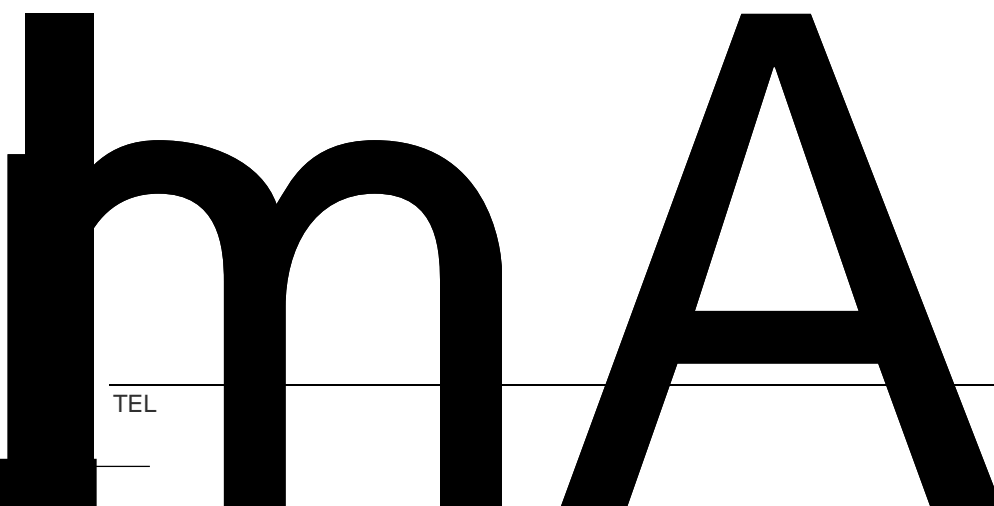

ORDERING INFORMATION

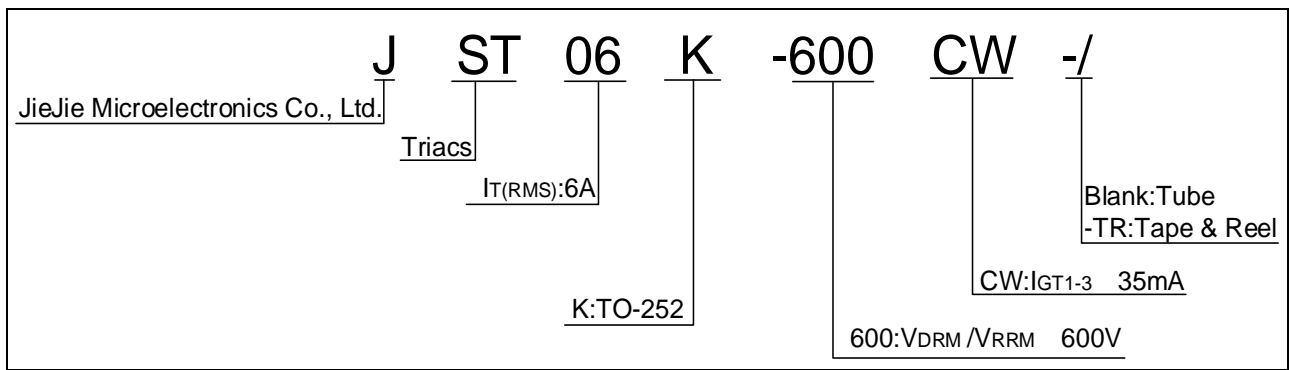

MARKING

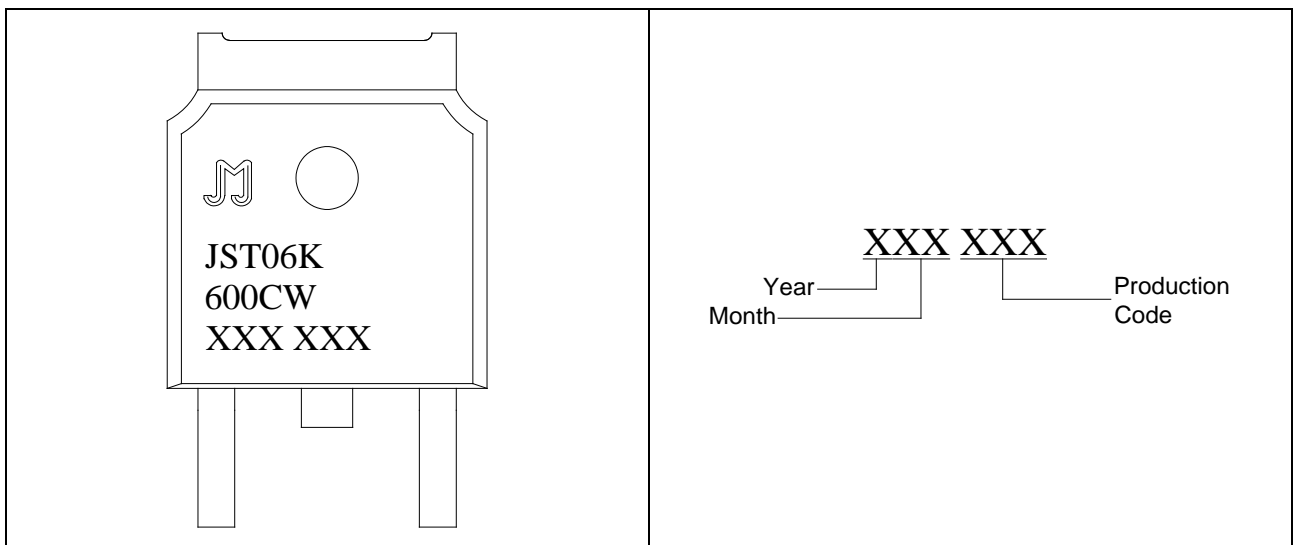

FIG.1: Maximum power dissipation versus RMS on-state current

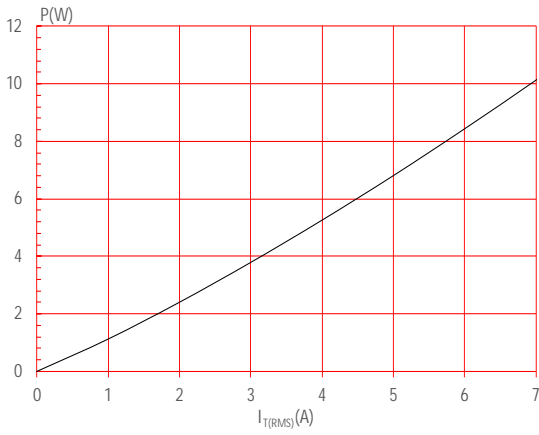
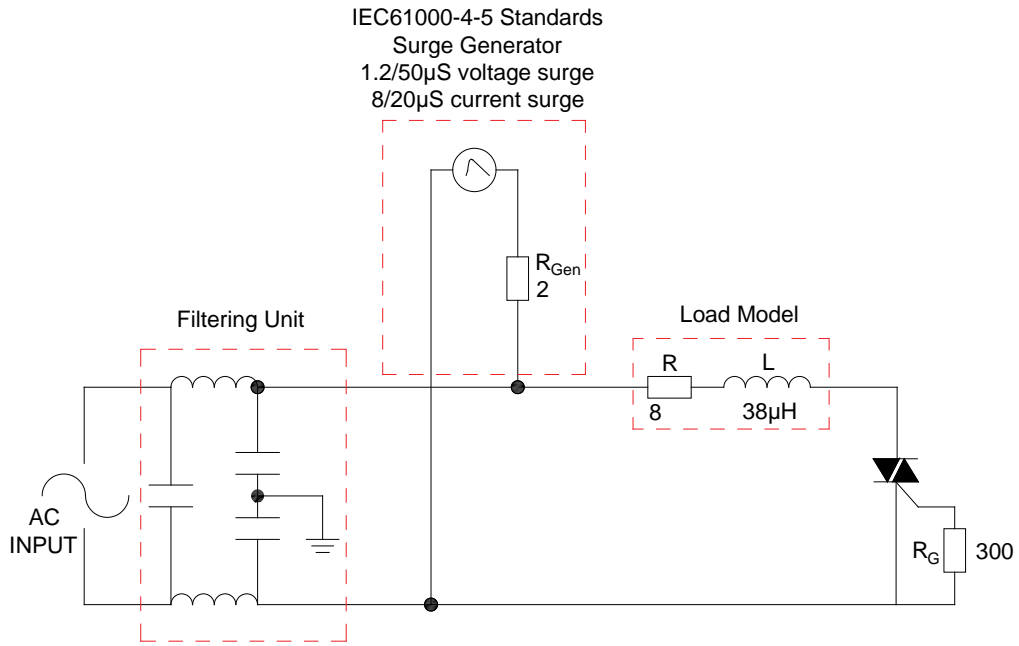

FIG.2: RMS on-state current versus case temperature



FIG.1) R MS on-state current vs. T_c

FIG.8 Test circuit for inductive and resistive loads to IEC-61000-4-5 standards



ORDERING INFORMATION

Order code	Voltage V_{DRM}/V_{RRM} (V)	IGT(mA)	Package	Base qty. (pcs)	Delivery mode
		- -			
JST06K-600CW	600	35	TO-252	80	Tube
JST06K-600CW-TR				2,500	Tape & Reel

Document Revision History

Date	Revision	
------	----------	--

PACKAGE MECHANICAL DATA

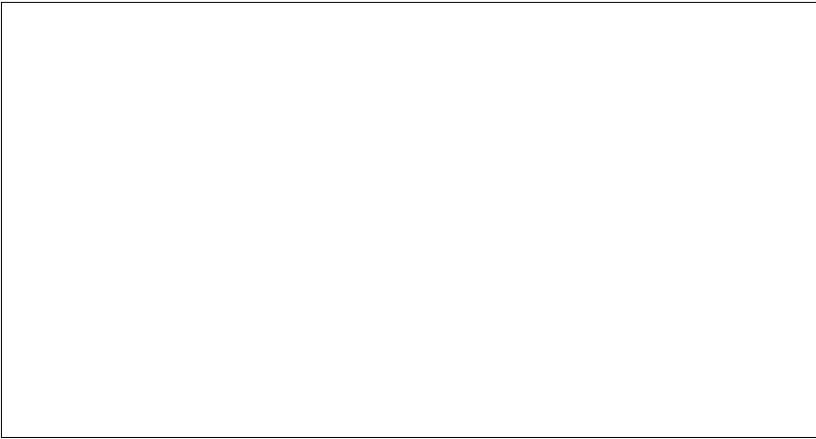

DELIVERY MODE

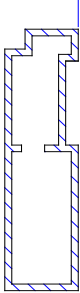

Information furnished in this document is believed to be accurate and reliable. However, Jiangsu JieJie Microelectronics Co., Ltd. assumes no responsibility for the consequences of use without consideration for such information nor use beyond it. Information mentioned in this document is subject to change without notice, apart from that when an agreement is signed, Jiangsu JieJie complies with the agreement.

Products and information provided in this document have no infringement of patents. Jiangsu JieJie assumes no responsibility for any infringement of other rights of third parties which may result from the use of such products and information. This document supersedes and replaces all information previously supplied.



is a registered trademark of Jiangsu JieJie Microelectronics Co., Ltd.

Copyright © 2025 Jiangsu JieJie Microelectronics Co., Ltd. All rights reserved.