



JST08X-1100CW 8A TRIAC

Rev.A.1.1

DESCRIPTION:

The JST08X-1

ORDERING INFORMATION

	<u>J</u>	<u>ST</u>	<u>08</u>	<u>X</u>	<u>-1100</u>	<u>CW</u>
JieJie Microelectronics Co., Ltd.	CS		<u>I_{T(RMS)}:8A</u>			
			<u>X:TO-220F(Ins)</u>			<u>CW:I_{GT1-3} 35mA</u>
					<u>1100:V_{DRM}/V_{RRM} 1100V</u>	

M...NG

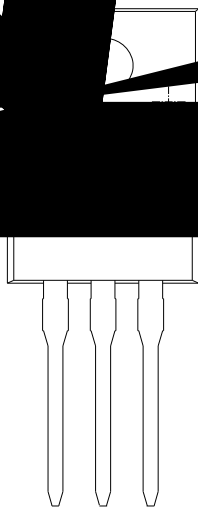

FIG.1: Maximum power dissipation versus RMS on-state current

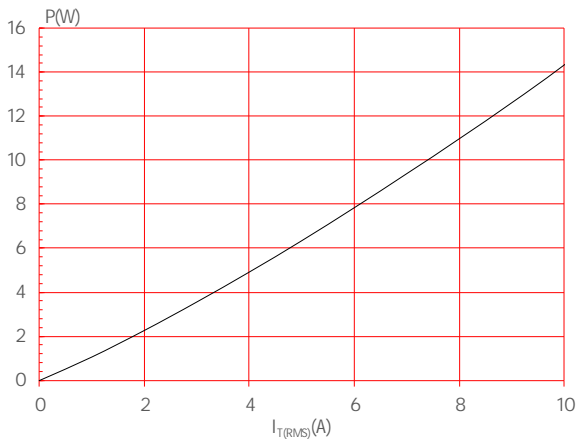

FIG.2: RMS on-state current versus case temperature

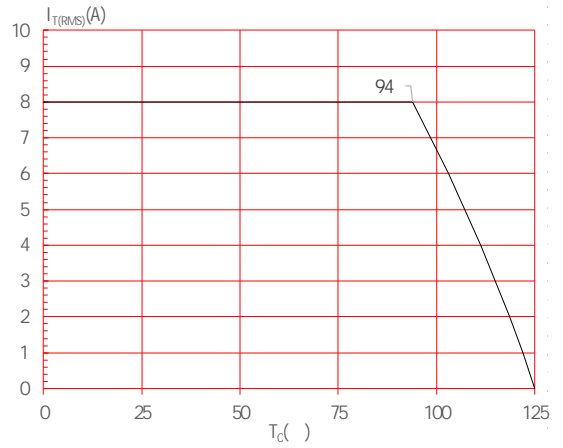

FIG.3: Surge peak on-state current versus number of cycles

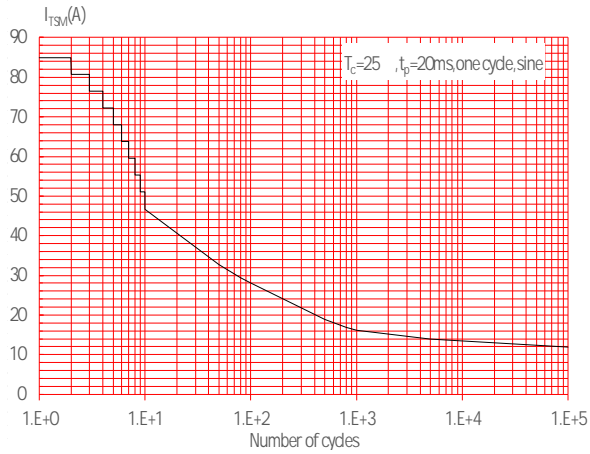

FIG.4: On-state characteristics

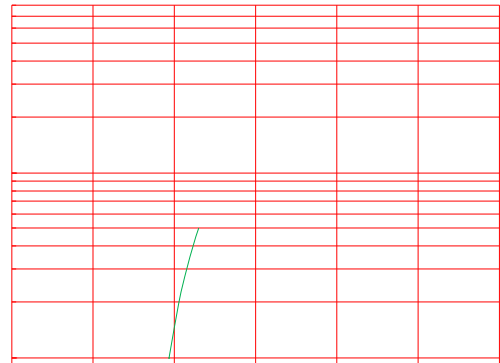
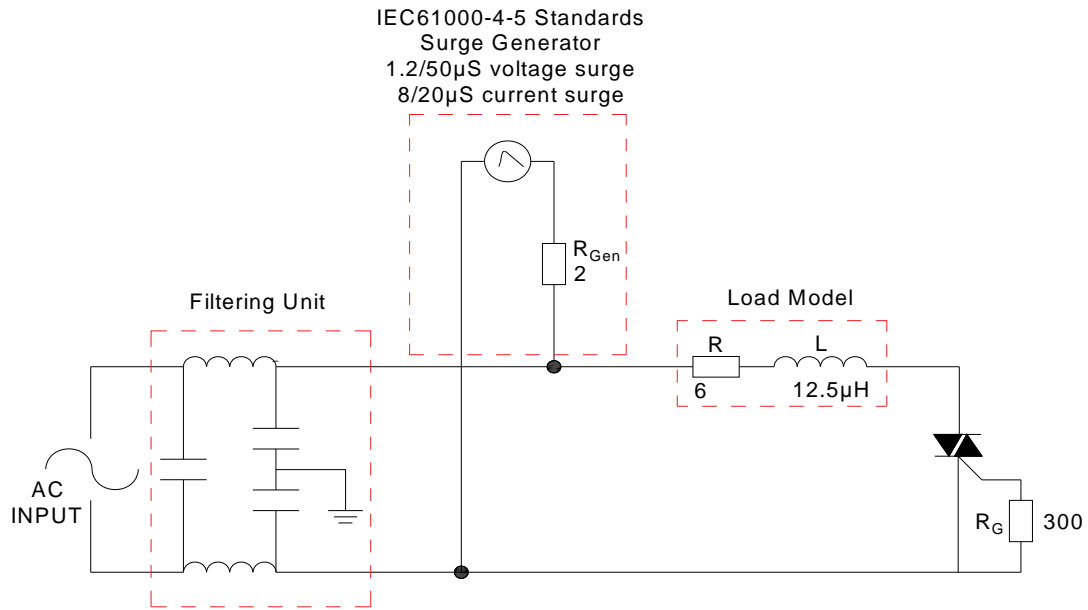

FIG.7 Test circuit for inductive and resistive loads to IEC-61000-4-5 standards



ORDERING INFORMATION

Order code	Voltage V _{DRM} /V _{RRM} (V)	IGT(mA)	Package	Base qty. (pcs)	Delivery mode
		- -			
JST08X-1100CW	1100	35	TO-220F(Ins)	50	Tube

Document Revision History

Date	Revision	Changes t	1	1	BDse
------	----------	-----------	---	---	------

PACKAGE MECHANICAL DATA

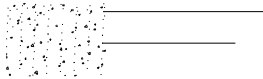

Information furnished in this document is believed to be accurate and reliable. However, Jiangsu JieJie Microelectronics Co., Ltd. assumes no responsibility for the consequences of use without consideration for such information nor use beyond it. Information mentioned in this document is subject to change without notice, apart from that when an agreement is signed, Jiangsu JieJie complies with the agreement.

Products and information provided in this document have no infringement of patents. Jiangsu JieJie assumes no responsibility for any infringement of other rights of third parties which may result from the use of such products and information. This document supersedes and replaces all information previously supplied.

 is a registered trademark of Jiangsu JieJie Microelectronics Co., Ltd.

Copyright © 2025 Jiangsu JieJie Microelectronics Co., Ltd. All rights reserved.