



DESCRIPTION:

The JST136C-800T triac is suitable for general purpose AC switching. It can be used as an ON/OFF function in applications such as heating regulation, induction motor starting circuits, for phase control operation in light dimmers, motor speed controllers. From T2 terminals to external heatsink. Package TO-220C is RoHS compliant.

MAIN FEATURES

ABSOLUTE MAXIMUM RATINGS

Parameter	Symbol	Value	Unit
Storage junction temperature range	T_{stg}	-40-150	
Operating junction temperature range	T_j	-40-125	
Repetitive peak off-state voltage ($T_j=25^\circ\text{C}$)	V_{DRM}	800	V
Repetitive peak reverse voltage ($T_j=25^\circ\text{C}$)	V_{RRM}	800	V
RMS on-state current ($T_c=110^\circ\text{C}$)	$I_{T(RMS)}$	4	A
Non repetitive surge peak on-state current (full cycle, $t_p=20\text{ms}$, $T_j=25^\circ\text{C}$)	I_{TSM}	35	A
Non repetitive surge peak on-state current (full cycle, $t_p=16.6\text{ms}$, $T_j=25^\circ\text{C}$)		38.5	

ORDERING INFORMATION

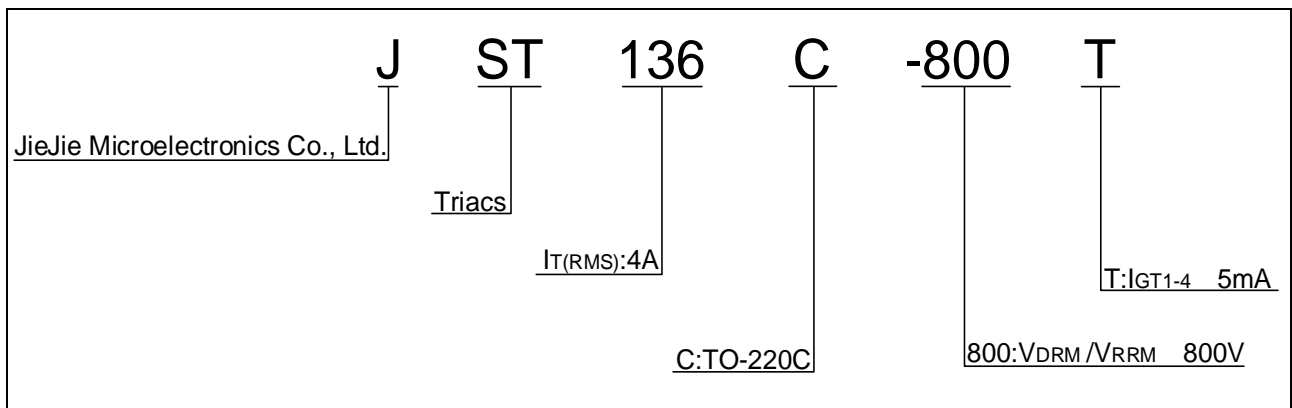

MARKING

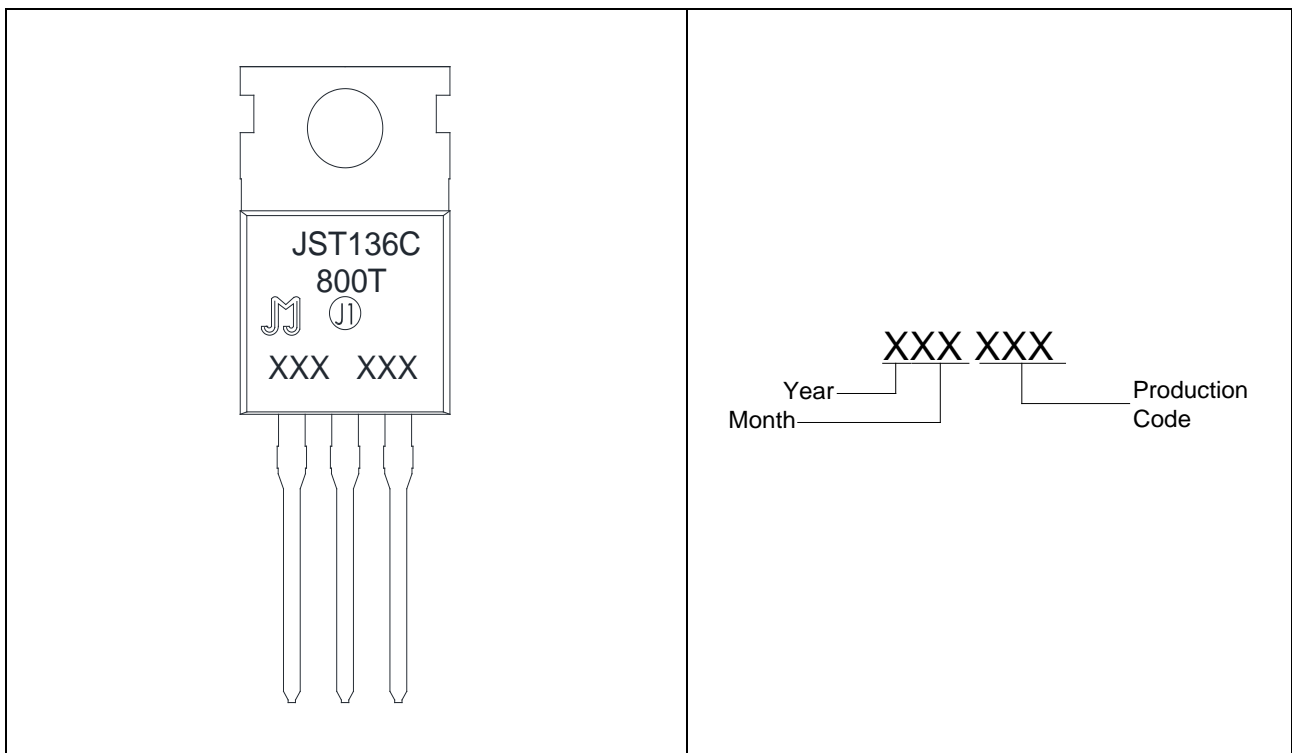

FIG.1: Maximum power dissipation versus RMS on-state current

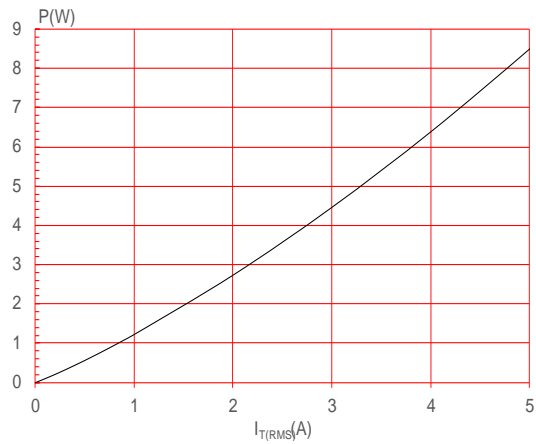

FIG.2: RMS on-state current versus case temperature

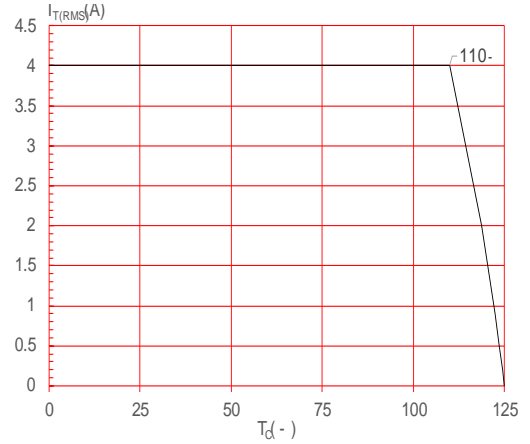

FIG.3: Surge peak on-state current versus number of cycles

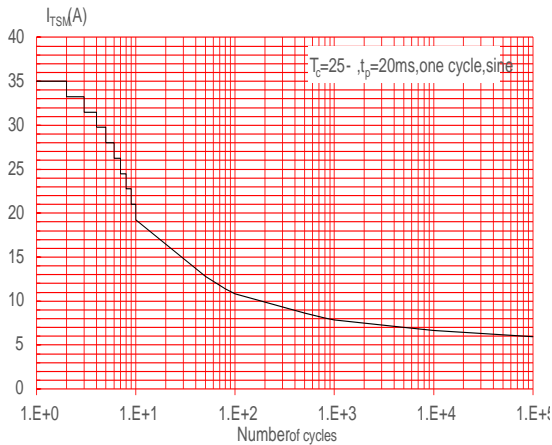

FIG.4: On-state characteristics

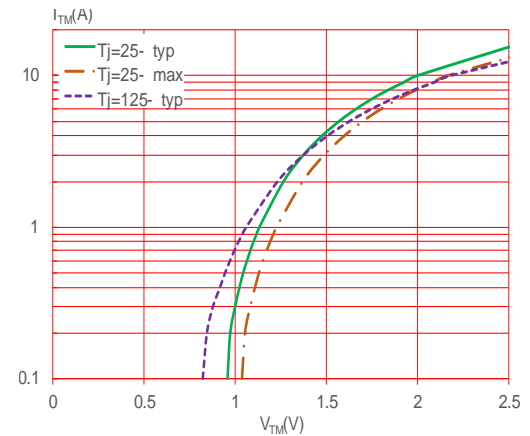

FIG.5: Non-repetitive surge peak on-state current for a sinusoidal pulse with width $t_p < 20\text{ms}$, and corresponding value of I^2t (- : $di/dt < 50\text{A}/\mu\text{s}$; - : $di/dt < 30\text{A}/\mu\text{s}$)

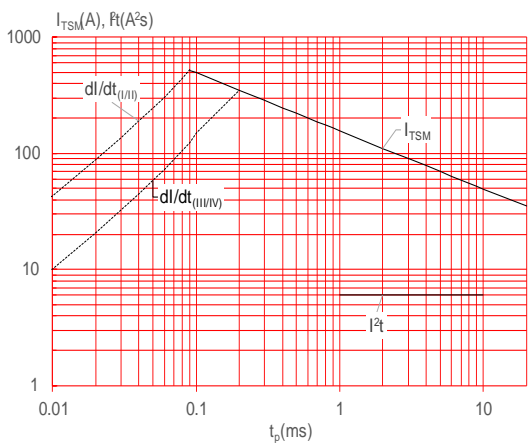

FIG.6: Relative variations of gate trigger current, holding current and latching current versus junction temperature

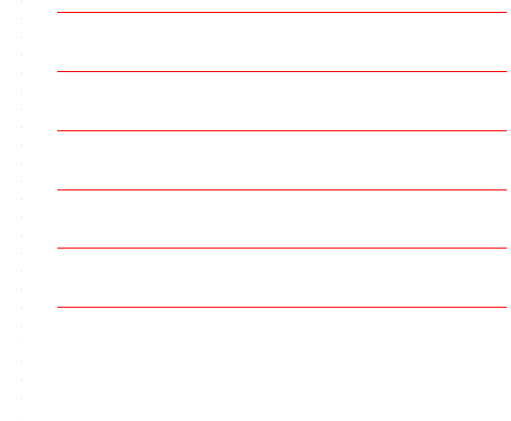
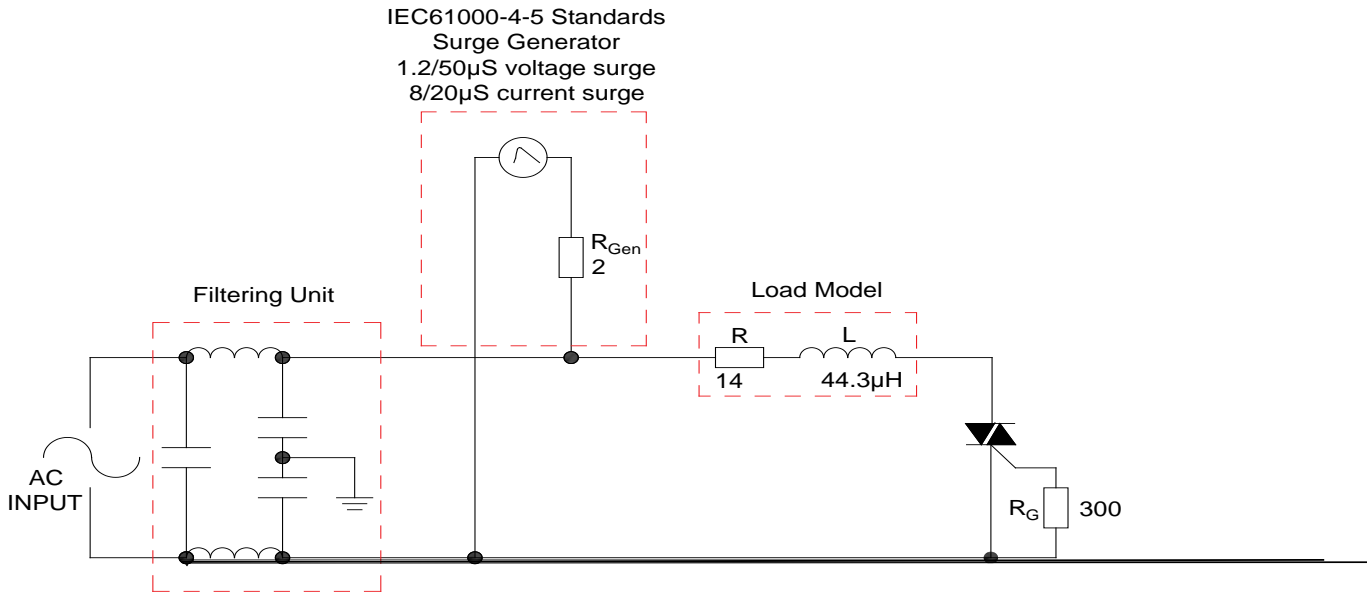

FIG.7 Test circuit for inductive and resistive loads to IEC-61000-4-5 standards



ORDERING INFORMATION

Order code	Voltage V _{DRM} /V _{RRM} (V)	IGT(nA)	Package	Base qty. (pcs)	Delivery mode
		H- I- J- K			
JST136C-800T	800	5	TO-220C	50	Tube

Document Revision History

Date	Revision	Changes
Apr.14, 2023	A.1.0	Last updated
Oct.16, 2025	A.1.1	Revise PACKAGE MECHANICAL DATA

PACKAGE MECHANICAL DATA

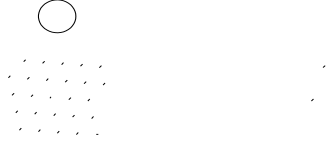

Information furnished in this document is believed to be accurate and reliable. However, Jiangsu JieJie Microelectronics Co.,